



SLA-2M6002D

2M Lens Module for PNM-7002VD



Key Features

- 0.055Lux@F2.0 Color, B/W
- 6.0mm fixed lens (2MP)

SLA-2M6002D

2M Lens Module for PNM-7002VD

Specifications

Video

Imaging Device	1/2.8" CMOS
Min. Illumination	Color: 0.055Lux(F2.0, 1/30sec)

Lens

Focal Length (Zoom Ratio)	6.0mm fixed focal
Max. Aperture Ratio	F2.0
Angular Field of View	H: 50.4°, V: 28.8°, D: 58.1°
Focus Control	Fixed

Pan / Tilt / Rotate

Pan / Tilt / Rotate Range	-176°~+176° / 0°~74° / -90°~+90°
---------------------------	----------------------------------

Mechanical

Color / Material	Black / Plastic
Product dimensions / weight	Ø35.5x35.9mm, 30g

SLA-2M6002D

2M Lens Module for PNM-7002VD

CAD

Unit: mm [inch]

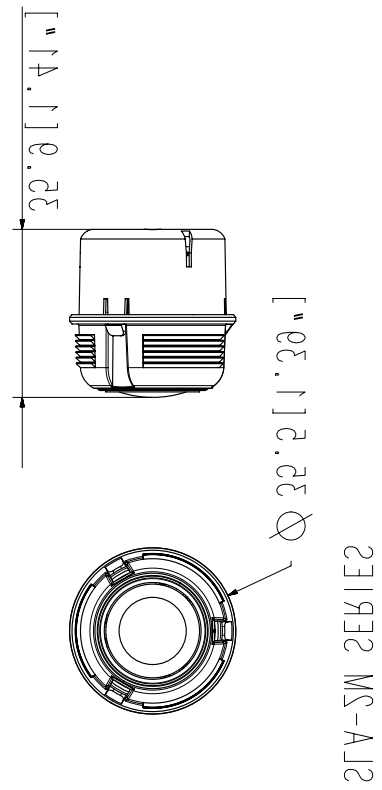
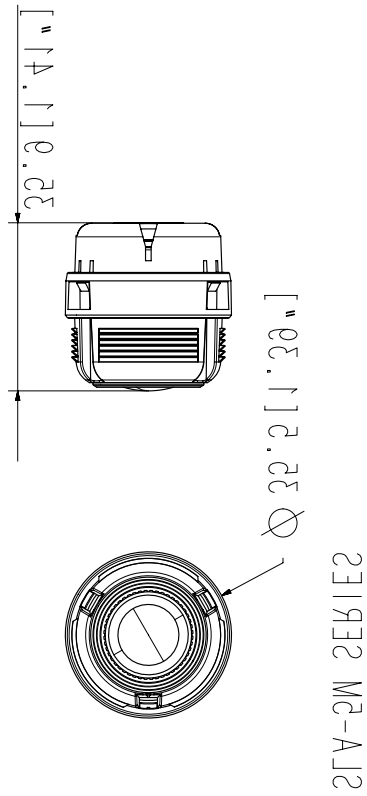

(14.1) mm : 10.7