

Four-channel Basic Night Color (VU-MORE Color) Security System

Four (4) 4MP Network Cameras and One (1) Four-channel NVR



WizSense

WizSense Series devices combine Dahua's powerful Analytics+ with an intuitive and easy to use interface. WizSense devices offer Smart Motion Detection+ and Perimeter Protection functions that focus on human and vehicular images and ignore irrelevant images to capture important video while reducing false alarms. WizSense Series devices provide powerful general surveillance for small to medium size businesses at a sensible price.

System Overview

The Dahua VU-MORE Color Lite Series camera offers multiple features such as motion detection and Smart Dual Illumination to provide deterrence, overtness, and full-color video. The camera provides increased color viewing at night for a variety of small to mid-size applications at an affordable price.

Dahua's Lite Series network video recorders offer excellent performance and high recording quality for network video security applications. For applications where details are critical for identification, this professional NVR provides a powerful processor with up to 4K resolution. Additionally, the NVR features a mouse shortcut operation menu, remote management and control, center storage, edge storage, and back up storage.

Functions

Perimeter Protection

Dahua Analytics+ includes Tripwire and Intrusion functions that offer custom tripwires based on object type for automation in limited access areas. Perimeter Protection requires less pixels to detect an object to deliver improved accuracy and decreased false alarms due to lights, weather, trees, or animals.

Smart Motion Detection+

Smart Motion Detection+, a component of Dahua's Analytics+ technology, improves alarm accuracy and decreases the number of false alarms. The advanced SMD+ algorithm analyzes a scene for human or vehicle motion, while filtering out other motion due to trees, leaves, animals, weather, and triggers an alarm when detected.

Smart H.265+

Smart H.265+ is the optimized implementation of the H.265 codec that uses a scene-adaptive encoding strategy, dynamic GOP, dynamic ROI, flexible multi-frame reference structure and intelligent noise reduction to deliver high-quality video without straining the network. Smart H.265+ technology reduces bit rate and storage requirements by up to 70% when compared to standard H.265 video compression.

4MP Network Cameras

- 4MP at 20 fps Maximum Resolution, 2.8 mm Fixed Lens
- Analytics+ Function – Perimeter Protection and Smart Motion Detection+
- Smart Dual Illumination — IR and White Light
- True WDR (120 dB) and Day/Night (ICR)

Four-channel NVR

- Lite Series NVR with Four (4) Channels
- One (1) SATA III Port, Up to 10 TB capacity per HDD
- Maximum 80 Mbps Recording Bandwidth
- Compatible with DMSS Application

Smart Dual Illuminators

The camera offers both IR and white-light illuminators and intelligently employs each depending on the situation. Typically, the camera enters the IR mode as ambient light decreases. When the camera detects a person entering the monitoring area, it activates the white-light illuminator to capture full-color details. Once the person leaves the area, the camera switches back to IR illumination.

Smart IR Technology

With IR illumination, detailed images can be captured in low light or total darkness. The camera's Smart IR technology adjusts the intensity of the camera's infrared LEDs to compensate for the distance of an object. Smart IR technology prevents IR LEDs from whitening out images as they come closer to the camera. The camera's integrated infrared illumination provides high-performance in extreme low-light environments up to 30 m (98.43 ft).

Environmental

Subjected to rigorous dust and water immersion tests the camera suitable for the most demanding outdoor applications. The camera carries an IP67 rating that ensures protection from total dust ingress and protection from water immersion between 15 centimeters and 1 meter in depth.

4K Resolution

4K resolution is a revolutionary breakthrough in image processing technology. 4K delivers four times the resolution of Full HD 1080p devices and offers superior picture quality and image details. 4K resolution improves the clarity of a magnified scene to view or record crisp forensic video from large areas.

Analytics+ Recording

Working with Dahua WizSense network cameras, the NVR recognizes and records video that contains analytic data on all IP channels. The NVR records intelligence at-the-edge features, including Perimeter Protection, Smart Motion Detection+, and People Counting.

Compatible with DMSS

The DMSS app is available on the iOS App Store and the Google Play Store. DMSS makes security easy and simple, allowing remote access to back-end devices, view live video, receive event push notifications, and search for recorded videos from an iPhone, iPad, or Android phone at anytime from virtually anywhere.

Technical Specification

N42DJS2 4MP VU-MORE Color Eyeball Network Camera

Camera

Image Sensor	1/3-in. CMOS
Effective Pixels	2688 (H) × 1520 (V), 4MP
Scanning System	Progressive
RAM/ROM	128 MB/128 MB
Electronic Shutter Speed	Auto, Manual, 1/3 s to 1/100,000 s
Minimum Illumination	0.008 lux at F1.6 (Color, 30 IRE) 0.0008 lux at F1.6 (B/W, 30 IRE) 0 lux (Illuminator on)
S/N Ratio	> 56 dB
IR Distance	30 m (98.43 ft) (IR), 15 m (49.21 ft) (Warm light)
IR On/Off Control	Auto; Manual
Illuminators	One (1) IR LED, One (1) Warm Light

Lens

Lens Type	Fixed-focal			
Iris Type	Fixed			
Mount Type	M12			
Focal Length	2.8 mm			
Maximum Aperture	F1.6			
Angle of View	Horizontal	95°		
	Vertical	52°		
	Diagonal	114°		
Close Focus Distance	0.9 m (2.95 ft)			
DORI ¹ Distance	Detect	Observe	Recognize	Identify
	63.6 m (208.66 ft)	25.4 m (83.33 ft)	12.7 m (41.67 ft)	6.4 m (20.99 ft)

Pan / Tilt / Rotation

Pan/Tilt/Rotation	Pan: 0° to 360° Tilt: 0° to 78° Rotation: 0° to 360°
-------------------	--

Video

Compression	Smart H.265+, Smart H.264+, H.264H, H.265, H.264, H.264B, MJPEG (Only supported by the sub stream)	
Streaming Capability	Two (2) Streams	
Resolution	4MP (2688 × 1520), 3.6MP (2560 × 1440), 3MP (2304 × 1296), 1080p (1920 × 1080), 1.3MP (1280 × 960), 720p (1280 × 720), D1 (704 × 480), VGA (640 × 480), CIF (352 × 240)	
Frame Rate	Main Stream	2688 × 1520 at 20 fps
	Sub Stream	704 × 480 at 20 fps
Bit Rate	H.264: 32 kbps to 6144 kbps H.265: 12 kbps to 6144 kbps	
Bit Rate Control	CBR, VBR	
Day/Night	Auto (ICR); Manual	
BLC Mode	BLC, HLC, True WDR (120 dB)	
White Balance	Auto, Natural, Street Lamp, Outdoor, Manual, Regional, Custom	
Gain Control	Auto, Gain Priority, Shutter Priority, Manual	
Noise Reduction	3DNR	
Motion Detection	Off, On (4 Zones, Rectangle)	
Region of Interest	Off, On (4 Zones)	
Smart IR	Supported	
Image Rotation	0°, 90°, 180°, 270°	
Mirror	Off, On	
Privacy Masking	Off, On (4 Areas, Rectangle)	

Audio

Built-in Microphone	Yes
Compression	G.711a, G.711Mu, PCM, G.726

Network

Ethernet	RJ-45 (10/100 Base-T)
Protocol	IPv4, IPv6, HTTP, TCP, UDP, ARP, RTP, RTSP, RTCP, RTMP, SMTP, FTP, SFTP, DHCP, DNS, DDNS, NTP, Multicast, ICMP, IGMP
Interoperability	ONVIF (Profile S, Profile T), CGI, P2P, Milestone, SDK, API
Maximum User Access	6 (Total bandwidth: 36 M)
Edge Storage	FTP, SFTP, Micro SD Card Slot (Maximum 256 GB)
Web Viewer	IE, Chrome, Firefox
Management Software	DSS, DMSS
Mobile Operating System	iOS, Android
Cyber Security	Configuratn Encrypton, Trusted Executon, Digest, Security Logs, WSSE, Account Lockout, Syslog, Video Encrypton, 802.1x, IP/MAC Filtering, HTTPS, Trusted Upgrade, Trusted Boot, Firmware Encrypton, Generating and Importing X.509 Certificaton

Certifications

Safety	EN 62368-1
Electromagnetic Compatibility (EMC)	FCC CFR 47 Part 15 Subpart B Electromagnetic Compatibility Directive 2014/30/ EU

Electrical

Power Supply	12 VDC or PoE (802.3af)	
Power Consumption	Basic	1.9 W (12 VDC), 2.4 W (PoE)
	Maximum	5.2 W (12 VDC), 5.9 W (PoE) (H.265 + Intelligence + WDR + Warm Light)

Environmental

Operating Conditions	-40°C to +60°C (-40°F to +140°F), < 95% RH
Storage Conditions	-40°C to +60°C (-40°F to +140°F)
Ingress Protection	IP67

Construction

Casing	Metal
Dimensions	100.9 mm × Φ109.9 mm (3.97 in. × Φ4.33 in.)
Net Weight	0.37 kg (0.82 lb)
Gross Weight	0.51 kg (1.12 lb)

Analytics+ Functions

Perimeter Protection	<ul style="list-style-type: none"> Detects human or vehicle violations using the following methods: <ul style="list-style-type: none"> Tripwire: a target crosses a defined line. Intrusion: a target enters or exits a defined perimeter. Monitors a combination of detection methods. Search and retrieve video based on target type.
Intelligent Search	Works with a Smart NVR to perform and refine intelligent searches, event extraction and merging to event videos
Smart Motion Detection+ ²	<ul style="list-style-type: none"> Differentiates between and classifies human and vehicle objects. Filters false alarms due to leaves, lights, animals, and other inconsequential objects. Extracts human or vehicle objects from recorded video for quick target search and retrieval.

Intelligent Video System Functions

IVS triggers an alarm and takes a defined action for the following events:	<ul style="list-style-type: none"> Tampering with the camera. Error writing to an onboard Micro SD card. Error sending or receiving data over the network. Unauthorized access to the camera. IP Address Conflict
Standard Features	

Technical Specification**N41C1P2 Four-channel 4K Network Video Recorder (2 TB)**

System

Main Processor	Industrial-grade Embedded Processor
Operating System	Embedded Linux

Audio and Video

IP Camera Input	Four (4) Channels	
Audio	Input	One (1) Channel, RCA
	Output	One (1) Channel, RCA

Analytics+ Recording³

Perimeter Protection	Channels	Four (4)
	Search	By channel, time, event type
Smart Motion Detection+	Channels	Four (4)
	Search	By target classification (human or vehicle)

Display

Interface	One (1) HDMI, One (1) VGA
Native Output Resolution	3840 x 2160, 1920 x 1080, 1280 x 1024, 1280 x 720
Maximum Decoding	Two (2) Channel of 8MP at 30 fps Four (4) Channels of 4MP at 30 fps
Multi-screen Display	1/4
On-screen Display	Camera Title, Time, Video Loss, Camera Lock, Motion Detection, Recording

Recording

Video Compression	Smart H.265+, H.265, Smart H.264+, H.264, MJPEG
Audio Compression	PCM, G.711A, G.711Mu, G.726
Supported IP Camera Resolution	8MP, 6MP, 5MP, 4MP, 3MP, 1080p, 720p, D1
Maximum Recording Bandwidth	80 Mbps
Record Mode	Manual Recording; Alarm Recording; SMD+ Recording; Smart Recording

Video Detection and Alarm

General Alarms	Motion Detection, Privacy Masking, Video Loss, Scene Changing, PIR Alarm, IPC External Alarm
Anomaly Alarms	Camera Disconnection, Storage Error, Disk Full, IP Conflict, MAC Conflict, Login Locked, Cybersecurity Exception
Analytics+ Alarms	Face Detection, Perimeter Protection (Intrusion and Tripwire), IVS, People Counting, Heat Map, SMD+
Alarm Actions	Recording, Snapshot, Audio, Buzzer, Log, Preset, Email

Playback and Backup

Sync Playback	1/4
Search Mode	Time/Date, Alarm, MD and Exact Search (Accurate to One (1) Second), Smart Search
Playback Function	Play, Pause, Stop, Rewind, Fast Play, Slow Play, Reverse, By Frame, Full Screen, Backup Selection (Video Clip or File), Partial Zoom, Audio On/Off
Backup Mode	USB Device, Network

Third-party Support

Brands	Dahua, Arecont Vision, AXIS, Bosch, Brickcom, Canon, CP Plus, Dynacolor, Honeywell, Panasonic, Pelco, Samsung, Sanyo, Sony, Videotec, Vivotek, and others
--------	---

Network

Ethernet	One (1) RJ-45 Port (10/100 Mbps), Self-adaptive
PoE	Four (4) Ports (IEEE802.3af/at)
Network Function	HTTP, HTTPS, TCP/IP, IPv4/IPv6, UPnP, SNMP, RTSP, UDP, SMTP, NTP, DHCP, DNS, IP Filter, DDNS, FTP, Alarm Server, IP Search (Supported for Dahua IP cameras, DVRs, NVRs), P2P, Auto-register
Maximum User Access	128
Mobile Operating System	iOS, Android

Browser	Chrome, Microsoft Edge
Interoperability	ONVIF (Profile S, T, and G), CGI, SDK
Storage	
Internal HDD	One (1) SATA III Port, Up to 10 TB capacity per HDD
HDD Mode	Single
Auxiliary Interface	
USB	Two (2) USB 2.0 Ports (Rear Panel)
Electrical	
Power Supply	48 VDC, 1.25 A
NVR Power Consumption	< 10 W, without HDD
Total PoE Budget	25.5 W (Single Port), 36 W (Total)
Construction	
Dimensions (W x L x H)	204.60 mm x 206.40 mm x 45.60 mm (8.06 in. x 8.12 in. x 1.80 in.)
Net Weight	0.50 kg (1.10 lb), without HDD
Gross Weight	1.43 kg (3.15 lb), without HDD
Certifications	
Safety	EN62368-1, UL 62368-1, CAN/CSA C22.2 No.62368-1-14
Electromagnetic Compatibility (EMC)	CFR 47 FCC Part 15 Subpart B, EN55032, EN55024, EN55035, EN61000-3-2, EN61000-3-3, EN50130-4













- The DORI distance is a measure of the general proximity for a specific classification to help pinpoint the right camera for your needs. The DORI distance is calculated based on sensor specifications and lab test results according to EN 62676-4, the standard that defines the criteria for the Detect, Observe, Recognize and Identify classifications..
- Pair a Smart Motion Detection+ camera with a Dahua recording device that also offers SMD+ functionality to take advantage of SMD+ alarm filtering and object classification when searching and playing back recorded video.
- The recorder Analytics+ functions are available only when connected to a Dahua network camera with Analytics+ functionality.

Ordering Information

Type	Part Number	Description
Security System	N444E42C	<ul style="list-style-type: none"> 1 x N41C1P2 Four-channel 4K Network Video Recorder (2 TB) 4 x N42DJS2 4MP VU-MORE Color Eyeball Network Camera
Accessories (Optional)	PFA106	Mount Adapter
	PFA130-E	Waterproof Junction Box
	PFA151	Corner Mount
	PFA152-E	Pole Mount
	PFB220C	Ceiling Mount
	PFB305W	Wall Mount
	DH-PFB205W-E	Wall Mount Bracket
	DH-PFA200G	Gang Box Adapter
	DH-PFM321D-US	12 VDC, 1 A Power Adapter
	DHI-TF-P100 Series	Micro SDXC Cards (64 GB, 128 GB, or 256 GB)
	DH-PFM920I-5EU-U	305 m (1000 ft) CAT5e UTP Cable
	DH-PFM900-E	Integrated Mount Tester

Accessories

Optional:

		
PFA106 Mount Adapter	PFA130-E Waterproof Junction Box	PFA151 Corner Mount
		
PFA152-E Pole Mount	PFB220C Ceiling Mount	PFB305W Wall Mount
		
DH-PFB205W-E Wall Mount Bracket	DH-PFA200G Gang Box Adapter	DH-PFM321D-US 12 VDC, 1 A Power Adapter
		
DHI-TF-P100 Series Micro SDXC Cards (64 GB, 128 GB, or 256 GB)	DH-PFM920I-5EU-U 305 m (1000 ft) CAT5e UTP Cable	DH-PFM900-E Integrated Mount Tester

For all possible accessory combinations for this camera, please scan or click the QR code below to go to our accessory selector.



Installation

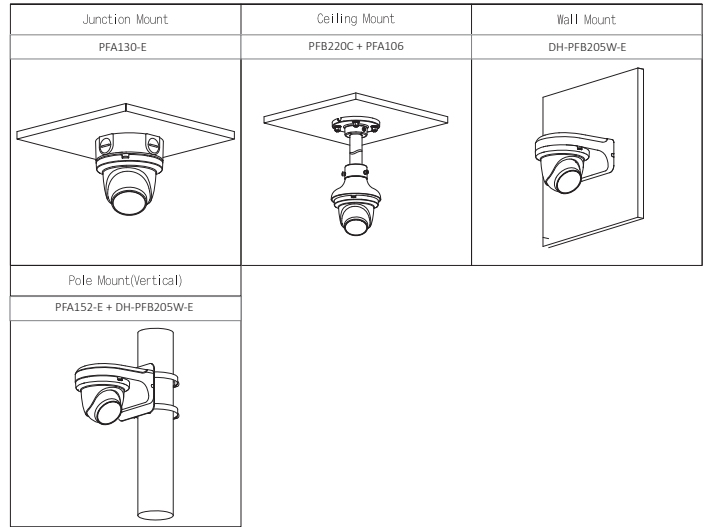

Dimensions (N42DJS2)

mm [in.]

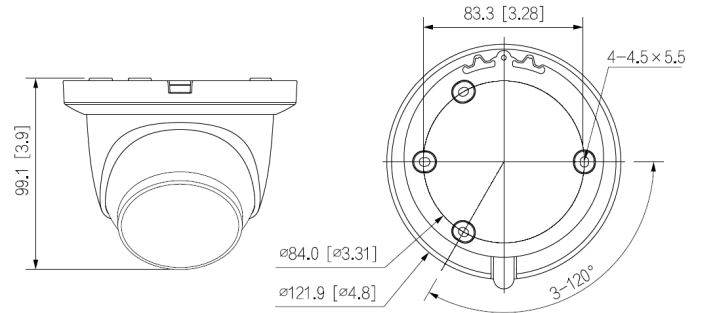

Dimensions (N41C1P2)

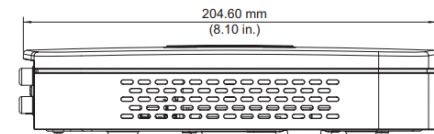
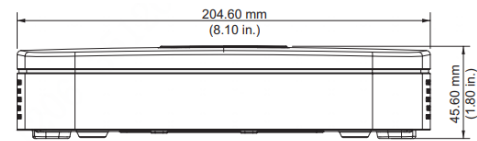

Rear Panel (N41C1P2)

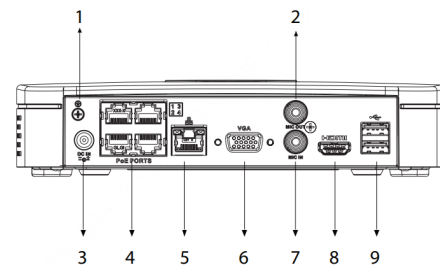

1	Ground	6	VGA Output
2	Audio Output, RCA (x1)	7	Audio Input, RCA (x1)
3	Power Input	8	HDMI Output
4	PoE Ports, RJ-45 (x4)	9	USB 2.0 Ports (x2)
5	Network Port, RJ-45		