

GV-TVD4810 AI 4MP H.265 5x Zoom Super Low Lux WDR Pro IR Vandal Proof IP

Dome



- AI deep learning: AI Perimeter Protection & Classification (Human, Vehicle)
- 1/3" progressive scan super low lux CMOS
- Min. illumination at 0.002 lux
- Triple streams from H.265, H.264 and MJPEG
- Wide Dynamic Range Pro (WDR Pro)
- Up to 30 fps at 2688 x 1520
- Motorized lens for remote focus / zoom adjustment
- Intelligent IR
- IR distance up to 40 m (130 ft)
- Day and Night function (with removable IR-cut filter)
- Vandal resistance (IK10 for metal casing)
- Ingress protection (IP67)
- 3-axis mechanism (pan / tilt / rotate)
- Built-in micro SD card slot (SD / SDHC / SDXC / UHS-I, Class 10) for local storage
- Two-way audio
- DC 12V / PoE (IEEE 802.3af)
- ONVIF (Profile G, S, T) conformant

Introduction

GV-TVD4810 is an outdoor, network camera equipped with an automatic IR-cut filter and IR LEDs for day and night surveillance. The camera supports H.265 video codec to achieve better compression ratio while maintaining high quality pictures at reduced network bandwidths. The camera adheres to IK10 and IP67 standards, and can be powered through PoE.

Empowered by deep learning algorithms, AI technology distinguishes human and vehicles from other moving objects. Integrated with GeoVision Video Management Software (VMS), it supports AI perimeter protection, real time alert, events playback and more.

Deep Learning Function

Face Detection



AI Perimeter Protection

(Intrusion, Crossing Line
Entering Area, Leaving Area)

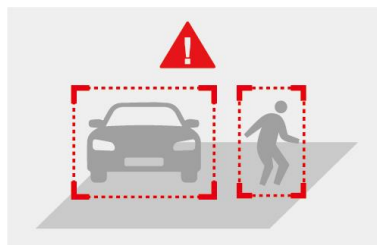

AI Event Search

(VMS V18.3 or later)



Note: The integration of AI events of the camera to GV-VMS is coming soon.

Dimensions

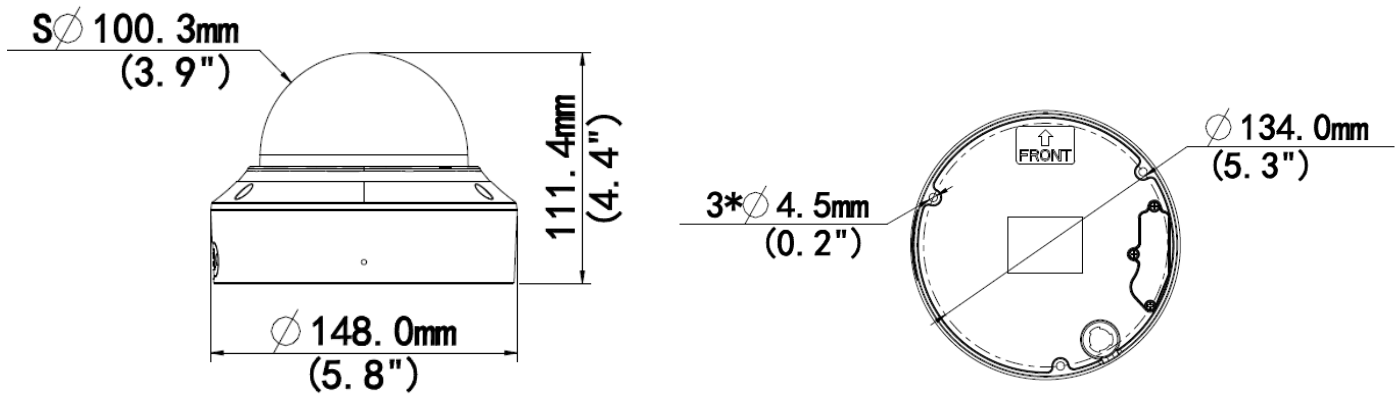

Specifications

Camera		
Image Sensor	1/3" progressive scan super low lux CMOS	
Picture Elements	2688(H) x 1520 (V)	
Minimum Illumination	Color	0.002 Lux (F1.2, AGC ON)
	IR On	0 Lux
Shutter Speed	Automatic, Manual 1 ~ 1/100000 sec)	
White Balance	Automatic, Manual	
Gain Control	Automatic, Manual	
S/N Ratio	56 dB	
WDR Pro	Yes	
Dynamic Range	120 dB	
Lens		
Megapixel	4 MP	
Day/Night	Yes (with removable IR-cut filter)	
Focal Length	2.7 ~ 13.5mm	
Lens Type	Motorized varifocal lens	
Maximum Aperture	F/1.2	
Mount	$\varnothing 14\text{mm}$	
Horizontal FOV	98~ 31°	
Operation	Focus	Automatic / Manual
	Zoom	5x Optical Zoom
	Iris	Fixed
IR LED Quantity	2 IR LEDs	
Max. IR Distance	40 m (130 ft)	
Operation		
Video Compression	H.265, H.264, MJPEG	
Video Streaming	Triple streams	
Frame Rate	30 fps at 2688 x 1520, 30 fps at 2560 x 1440, 30 fps at 2304 x 1296 (60 / 50 Hz) * The frame rate and performance may vary depending on the number of connections and data bitrates (different scenes).	
Video Analytics	Motion Detection, Tampering Alarm, Audio Detection *Tampering alarm and audio detection are only accessible through the camera's Web interface, which can be used to trigger alerts such as e-mail and FTP	
Image Setting	Brightness, Contrast, Saturation, Sharpness, Flicker-less, 3D Noise Reduction, Image Orientation (Flip, Mirror, 0°, 90°, 180°, 270°-including Corridor format)	
Audio Compression	G.711	
Audio Support	Two-way Audio (external speaker required)	
Digital I/O	Input	1 Input, dry contact, NO / NC
	Output	1 Relay Output (1A 30V DC / 0.3A 125V AC)

Face Detection		
Environment		100 lux
Detectable face angle	Tilt (Up/Down)	≤ 10°
	Swing (Left/Right)	≤ 30°
Max. number of faces		Up to 40
Min. face image pixel requirement		80 pixels
Deep Learning Function		
AI Analytics		Intrusion, Crossing Line, Entering Area, Face Detection, Leaving Area (Human & Vehicle classification), People Flow Counting, Crowd Density Monitoring
Video Resolution		
Main Stream		2688 x 1520 (Default), 2560 x 1440, 2304 x 1296, 1920 x 1080, 1280 x 720
Sub Stream		1280 x 720, 720 x 576, 704 x 288, 640 x 360 (Default), 640 x 480, 352 x 288
Third Stream (Closed by Default)		720 x 576, 704 x 288, 640 x 360, 352 x 288
Network		
Interface		10/100 Ethernet
Protocol		802.1x, ARP, DHCP, DDNS, DNS, DynDNS, FTP, HTTP, HTTPS, ICMP, IGMP, IPv4, NTP, PPPoE, QoS, RTCP, RTP, RTSP, SMTP, SNMP, TCP, UDP, UPnP, ONVIF (Profile G, S, T)
Mechanical		
Camera Angle Adjustment	Pan	0 ~ 355°
	Tilt	0 ~ 80°
	Rotate	0 ~ 355°
Connectors	Power	DC JACK (DC 12 V, 1.25 A), PoE
	Ethernet	RJ-45
	Audio	1 In (built-in or external microphone with power supply); 1 Out (Audio Out Wire)
	Digital I/O	4-pin terminal block pitch 3.5 mm (0.14")
	Local Storage	Micro SD card slot (SD / SDHC / SDXC / UHS-I, Class 10) * UHS-II card type is not supported.
General		
Operating Temperature		-30~ 60°C (-22 ~ 140°F)
Humidity		0 ~ 95% (no condensation)
Power Source		12 V DC / PoE (IEEE802.3af)
Max. Power Consumption		7.0 W
Dimensions		∅ 148 x 111 mm (∅ 5.8 x 4.4")
Weight		0.92 kg (2.03 lb)
Ingress Protection		IP67
Vandal Resistance		IK10 for metal casing
Regulatory		CE, FCC, RoHS compliant
Web Interface		
Installation Management		Web-based configuration
Maintenance		Firmware upgrade through Web Browser or Utility
Access from Web Browser		Live View, Video Recording, Change Video Quality, Bandwidth Control, Image Snapshot, Text Overlay, Image Masking
Language		Czech, English, French, German, Hungarian, Italian, Japanese, Polish, Portuguese, Russian, Spanish, Traditional Chinese
Applications		
Software Supported		GV-VMS (V17.4.2 / V18.2.1), GV-DVR / NVR (V8.9.1), GV-Control Center (V3.8.0), GV-Recording Server / Video Gateway (V2.0.0), GV-Edge Recording Manager Win version (V2.0.0), GV-Redundant / Failover Server (V1.2.0), GV-Mobile Server (V1.5.1)
Smart Device Access		GV-Eye for iOS and Android
Live Viewing		Browser (Chrome, Edge, Firefox, Safari), Mobile App











Note:

1. Patch files are required for some supported software.
2. Do not use clothes or any ordinary material to clean the camera cover since they may result in scratches.
3. Specifications are subject to change without notice.

Packing List

- | | |
|--------------------------|--------------------------|
| 1. GV-TVD4810 Dome | 4. Drill Template Paster |
| 2. Waterproof Rubber Set | 5. Torx Wrench |
| 3. Screw Kit | 6. Download Guide |

Accessories

Model No.	Name		Details
GV-Mount107 (must be used with GV-Mount 212-2)	Pendant Bracket		Dimensions: \varnothing 120 x 334 mm (\varnothing 4.72" x 13.15") Weight: 0.74 kg (1.63 lb)
GV-Mount211-2	Wall Mount and Junction Box		Dimensions: \varnothing 233 x 126 x 126 mm (\varnothing 9.2 x 5 x 5") Weight: 1 kg (2.2 lb)
GV-Mount212-2	Wall Box Mount		Dimensions: \varnothing 126 x 36 mm (\varnothing 5.0 x 1.4") Weight: 0.22 kg (0.48 lb)
GV-Mount300-2	Convex Corner Mount		Dimensions: 137 x 233 x 160 mm (5.4" x 9.17" x 6.3") Weight: 1.65 kg (3.64 lb)
GV-Mount310-2	Concave Corner Mount		Dimensions: 111.2 x 369.9 x 210 mm (2.6" x 11.4" x 6.6") Weight: 1.65 kg (3.64 lb)
GV-Mount420 (must be used with GV-Mount211-2)	Pole Mount Bracket		Dimensions: \varnothing 120 x 120 x 53.4 mm (\varnothing 4.7 x 4.7 x 2.1") Steel Strap Diameter: \varnothing 67 ~ 127 mm (\varnothing 2.6" ~ 5") Weight: 0.45 kg (0.99 lb)
GV-Mount606	In-Ceiling Mount		Dimensions: \varnothing 235 x 63 mm (\varnothing 9.3" x 2.5") In-ceiling hole: \varnothing 195 mm (\varnothing 7.67") Weight: 0.49 kg (1.1 lb)
GV-Mount704 (must be used with GV-Mount107)	Extension Tube		Dimensions: \varnothing 3.5 x 10 or 20 or 30 or 50 cm (\varnothing 1.38 x 3.9 or 7.9 or 11.8 or 19.7") Weight: 225g or 360g or 500g or 780g (0.5 lb or 0.79 lb or 1.1 lb or 1.72 lb)
GV-Mount921 (for standard US single and double gang boxes only)	Power Box Mount Bracket		Dimensions: \varnothing 145 x 13 mm (\varnothing 5.7" x 0.5") Weight: 0.13 kg (0.29 lb)
GV-PA191	Power over Ethernet (PoE) Adapter		GV-PA191 is a Power over Ethernet (PoE) adapter designed to provide power to the IP device through a single Ethernet cable.

GV-POE Switch

GV-POE Switch is designed to provide power along with network connection for IP devices. The GV-POE Switch is available in various models with different numbers and types of ports.

Power Adapter

Contact our sales representatives for the countries and areas supported.
