

GV-TVD4711 4MP H.265 4.3x Zoom Low Lux WDR Pro IR Vandal Proof IP Dome



- 1/3" progressive scan low lux CMOS
- Min. illumination at 0.003 lux
- Triple streams from H.265, H.264 and MJPEG
- Up to 30 fps at 2688 x 1520
- Motorized varifocal lens for remote focus / zoom adjustment
- Intelligent IR
- IR distance up to 30 m (100 ft)
- Day and Night function (with removable IR-cut filter)
- Vandal resistance (IK10 for metal casing)
- Ingress protection (IP66)
- 3-axis mechanism (pan / tilt / rotate)
- DC 12V / PoE (IEEE 802.3af)
- Built-in micro SD card slot (SD / SDHC / SDXC / UHS-I, Class 10) for local storage
- Two-way audio
- Wide Dynamic Range Pro (WDR Pro)
- Defog
- 3D noise reduction
- Motion detection
- Text overlay
- Privacy mask
- Tampering Alarm
- 12 languages supported
- ONVIF (Profile G, S, T) conformant

Introduction

The Vandal Proof IP Dome is an outdoor camera designed with IK10 vandal resistance and IP66 ingress protection. GV-TVD4711 supports H.265 video codec to achieve better compression ratio while maintaining high quality pictures at reduced network bandwidths. The camera is equipped with an automatic IR-cut filter and IR LEDs for day and night surveillance. Adjustable in 3 axes (pan, tilt and rotate), it offers an entry-level surveillance solution with all the essential features and excellent image quality.

Active Tampering Alarm

Tampered



Focus Change



Camera Shift

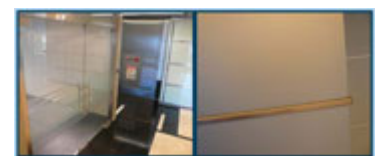

Dimensions

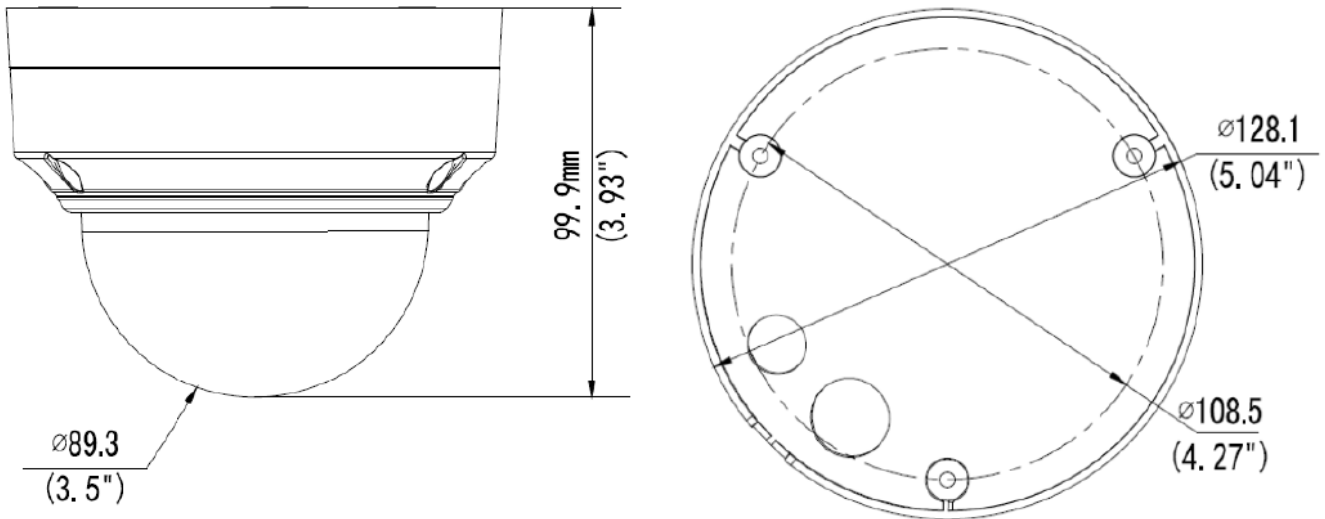

Specifications

Camera		
Image Sensor	1/3" progressive scan low lux CMOS	
Picture Elements	2688(H) x 1520 (V)	
Minimum Illumination	Color	0.003 Lux (F1.6, AGC ON)
	IR On	0 Lux
Shutter Speed	Automatic, Manual (1/6 ~ 1/100000 sec)	
White Balance	Automatic, Manual	
Gain Control	Automatic, Manual	
S/N Ratio	56 dB	
WDR Pro	Yes	
Dynamic Range	Up to 120 dB	
Lens		
Megapixel	4 MP	
Day/Night	Yes (with removable IR-cut filter)	
Focal Length	2.8 ~ 12 mm	
Lens Type	Motorized varifocal lens	
Maximum Aperture	F/1.6	
Mount	Ø14 mm	
Horizontal FOV	98~ 31°	
Operation	Focus	Automatic / Manual
	Zoom	4.3x Optical Zoom
	Iris	Fixed
IR LED Quantity	2 IR LEDs	
Max. IR Distance	30 m (100 ft)	
Operation		
Video Compression	H.265, H.264, MJPEG	
Video Streaming	Triple streams	
Video Resolution	Main Stream	2688 x 1520, 2560 x 1440 (Default), 2304 x 1296, 1920 x 1080
	Sub Stream	1280 x 720, 704 x 576, 704 x 288, 640 x 480, 640 x 360 (Default), 352 x 288
	Third Stream (Closed by Default)	640 x 360, 352 x 288
Frame Rate	30 fps at 2688 x 1520, 30 fps at 2560 x 1440, 30 fps at 2304 x 1296 (60 / 50 Hz) * The frame rate and performance may vary depending on the number of connections and data bitrates (different scenes).	
Video Analytics	Motion Detection, Tampering Alarm, Intrusion, Human Body Detection	

Image Setting	Brightness, Contrast, Saturation, Sharpness, Flicker-less, 3D Noise Reduction, Image Orientation, Exposure Mode, Shutter Speed, Gain Control, Slow Shutter, Backlight Compensation (BLC), Metering Control, D/N Sensitivity, WDR, Smart Illumination, White Balance, Defog	
Audio Compression	G.711	
Audio Support	Two-way Audio (external microphone and speaker required)	
Digital I/O	Input	1 Input, dry contact, NO / NC
	Output	1 Relay Output (1A 30V DC / 0.3A 125V AC)
Network		
Interface	10/100 Ethernet	
Protocol	ARP, DHCP, DDNS, DNS, DynDNS, FTP, HTTP, HTTPS, ICMP, IGMP, IPv4, NTP, PPPoE, QoS, RTCP, RTP, RTSP, SMTP, SNMP, TCP, UDP, UPnP, ONVIF (Profile G, S, T)	
Mechanical		
Camera Angle Adjustment	Pan	0 ~ 360°
	Tilt	0 ~ 120°
	Rotate	0 ~ 360°
Connectors	Power	2-pin terminal block (DC 12 V, 1.25 A), PoE
	Ethernet	RJ-45
	Audio	4-pin terminal block pitch 2.5 mm (0.1") (Audio In & Audio Out)
	Digital I/O	4-pin terminal block pitch 2.5 mm (0.1")
	Local Storage	Micro SD card slot (SD / SDHC / SDXC / UHS-I, Class 10) * UHS-II card type is not supported.
General		
Operating Temperature	-35 ~ 60°C (-31 ~ 140°F)	
Humidity	0 ~ 95% (no condensation)	
Power Source	12 V DC / PoE (IEEE802.3af)	
Max. Power Consumption	9.5 W	
Dimensions	Ø125.8 x 99.9 mm (Ø4.9" x 3.93")	
Weight	0.57 kg (1.26 lb)	
Ingress Protection	IP66	
Vandal Resistance	IK10 for metal casing	
Regulatory	FCC, CE, RoHS compliant	
Web Interface		
Installation Management	Web-based configuration	
Maintenance	Firmware upgrade through Web Browser or Utility	
Access from Web Browser	Live View, Video Recording, Change Video Quality, Bandwidth Control, Image Snapshot, Text Overlay, Image Masking	
Language	Czech, English, French, German, Hungarian, Italian, Japanese, Polish, Portuguese, Russian, Spanish, Traditional Chinese	
Applications		
Software Supported	GV-VMS (V17.3.0 / V18.1.1), GV-DVR / NVR (V8.8), GV-Control Center (V3.7.0), GV-Recording Server / Video Gateway (V1.4.2), GV-Edge Recording Manager Win version (V1.4.0), GV-Redundant / Failover Server (V1.1.0.0) *It is required to apply patch files to all the supported software.	
Smart Device Access	GV-Eye for iOS and Android	
Live Viewing	Internet Explorer, Non-IE browser (Chrome, Edge, Firefox, Safari), Mobile App *The non-IE browsers only support displaying live view with H.264.	









Note:

1. Do not use clothes or any ordinary material to clean the camera cover since they may result in scratches.
2. Specifications are subject to change without notice.

Packing List

- | | | |
|--------------------------------|-------------------------------|------------------|
| 1. IR Vandal Proof Dome | 5. 2-Pin Power Terminal Block | 9. Warranty Card |
| 2. Spare Waterproof Rubber Set | 6. Cable Protection Connector | |
| 3. Screw Kit | 7. Torx Wrench | |
| 4. Drill Template Paster | 8. Download Guide | |

Accessories

Model No.	Name		Details
GV-Mount107 (must be used with GV-Mount212-2)	Pendant Bracket		Dimensions: \varnothing 120 x 334 mm (\varnothing 4.72" x 13.15") Weight: 0.74 kg (1.63 lb)
GV-Mount211-2	Wall Mount and Junction Box		Dimensions: \varnothing 253 x 125 x 125 mm (\varnothing 10 x 4.9 x 4.9") Weight: 0.92 kg (2.02 lb)
GV-Mount212-2	Wall Box Mount		Dimensions: \varnothing 145 x 40 mm (\varnothing 5.7 x 1.6") Weight: 0.24 kg (0.5 lb)
GV-Mount300-2	Convex Corner Mount		Dimensions: 137 x 233 x 160 mm (5.4" x 9.17" x 6.3") Weight: 1.65 kg (3.64 lb)
GV-Mount310-2	Concave Corner Mount		Dimensions: 111.2 x 369.9 x 210 mm (2.6" x 11.4" x 6.6") Weight: 1.65 kg (3.64 lb)
GV-Mount420 (must be used with GV-Mount211-2)	Pole Mount Bracket		Dimensions: \varnothing 120 x 120 x 53.4 mm (\varnothing 4.7 x 4.7 x 2.1") Steel Strap Diameter: \varnothing 67 ~ 127 mm (\varnothing 2.6" ~ 5") Weight: 0.45 kg (0.99 lb)
GV-Mount606	In-Ceiling Mount		Dimensions: \varnothing 235 x 63 mm (\varnothing 9.3" x 2.5") In-ceiling hole: \varnothing 195 mm (\varnothing 7.67") Weight: 0.49 kg (1.1 lb)
GV-Mount704 (must be used with GV-Mount107)	Extension Tube		Dimensions: \varnothing 3.5 x 10 or 20 or 30 or 50 cm (\varnothing 1.38 x 3.9 or 7.9 or 11.8 or 19.7") Weight: 225g or 360g or 500g or 780g (0.5 lb or 0.79 lb or 1.1 lb or 1.72 lb)
GV-PA191	Power over Ethernet (PoE) Adapter		GV-PA191 is a Power over Ethernet (PoE) adapter designed to provide power to the IP device through a single Ethernet cable.
GV-POE Switch			GV-POE Switch is designed to provide power along with network connection for IP devices. The GV-POE Switch is available in various models with different numbers and types of ports.
Power Adapter			Contact our sales representatives for the countries and areas supported.