

GV-PTZ5810-IR AI 5MP H.265 5x Zoom Super Low Lux WDR Pro IR IP Mini PTZ



- AI deep learning: AI Perimeter Protection & Classification (Human, Vehicle)
- 1/2.7" progressive scan CMOS sensor
- Min. illumination at 0.003 lux
- Triple streams from H.265, H.264 or MJPEG
- Up to 30 fps at 2880 x 1620
- Motorized varifocal lens for remote focus / zoom adjustments
- 5x optical zoom
- Intelligent IR
- IR distance up to 30 m (100 ft)
- Day and night function (with removable IR-cut filter)
- Wide Dynamic Range Pro (WDR Pro)
- Built-in microphone and speaker
- Built-in micro SD card slot (SD / SDHC / SDXC / UHS-I, Class 10) for local storage
- DC 12V, PoE+ (IEEE 802.3at)
- Pan 350°
- Tilt from 0° to 90°
- Pan and tilt speed of up to 60° / sec and 50° / sec
- PTZ movement (Preset, Patrol)
- PTZ patrol by schedule
- AI analytics (Cross line, Intrusion, Enter Area, Leave Area, Face Detection, People Flow Counting, Crowd Density Monitoring)
- Auto focus
- 3D noise reduction
- Motion detection
- Privacy mask
- ONVIF (Profile G, S, T) conformant

Introduction

GV-PTZ5810-IR is an indoor network PTZ camera that offers 5x optical zoom, capable of showing smooth live view with great details. This camera can simultaneously deliver three video streams in resolutions up to 2880 x 1620 at 30 fps. In low-light environments, night vision is enhanced with its LEDs, which allow up to 30 m (100 ft) effective IR distance. The camera can process scenes with contrasting intensity of lights and produce clear image using the built-in WDR Pro. GV-PTZ5810-IR supports H.265 video codec to achieve better compression ratio while maintaining high quality pictures at reduced network bandwidths.

Wide surveillance coverage is made possible with 350° panning and 0° ~ 90° tilting capacity. PTZ functions such as Preset, and Patrol can be programmed and activated by schedule. GV-PTZ5810-IR supports pan / tilt speeds ranging from a patrol of 60° per second and 50° per second to a slow ramble of 0.1° per second with 0.1° pan accuracy for accurate tracking ability.

Deep Learning Function

Face Detection

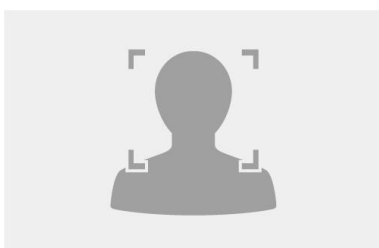

AI Perimeter Protection

(Intrusion, Crossing Line
Entering Area, Leaving Area)

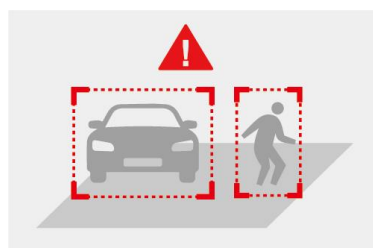

People Counting

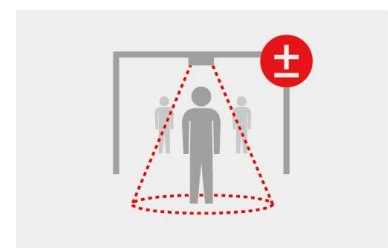

Dimensions

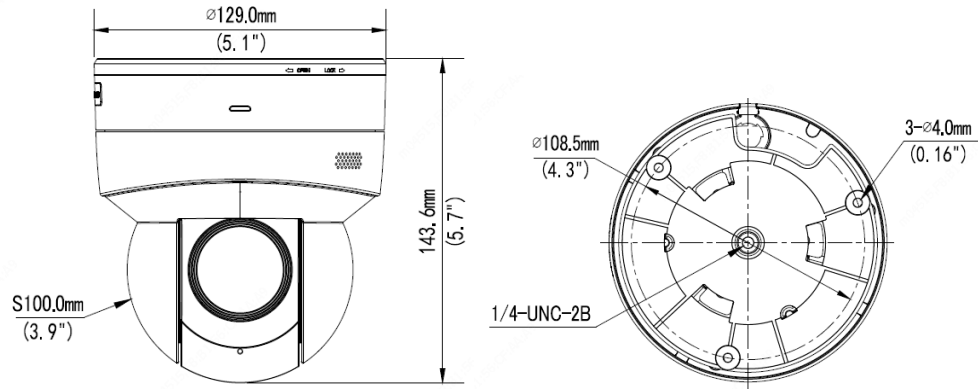

Specifications

Camera		
Image Sensor	1/2.7" progressive scan CMOS	
Optical Zoom	5x	
Minimum Illumination	Color	0.003 Lux (F1.2, AGC ON)
	IR ON	0 Lux
Electronic Shutter	Auto / Manual (1 ~ 1/100000 sec)	
White Balance	Auto / Manual	
Iris control	Fixed	
AGC control	Auto / Manual	
S/N Ratio	56 dB	
WDR	WDR Pro	
Dynamic Range	Up to 120 dB	
Optical Lens		
Megapixel	5 MP	
Day / Night	Yes (with removable IR-cut filter)	
Lens Type	Motorized varifocal lens	
Focal Length	2.7 ~ 13.5 mm	
Maximum Aperture	F/1.2	
Horizontal FOV	30.6° ~ 106.9°	
Operation	Focus	Auto / Manual
	Zoom	5x
	Iris	Fixed
IR LED Quantity	2 IR LEDs	
Max. IR Distance	30 m (100 ft)	
Video		
Video Compression	H.265, H.264, MJPEG	
Video Streaming	Triple streams from H.265, H.264 or MJPEG	
Video Resolution	Main Stream	2880 x 1620 (Default), 2560 x 1440, 2304 x 1296, 1920 x 1080, 1280 x 720, 720 x 576, 640 x 360
	Sub Stream	1280 x 720, 720 x 576, 640 x 480, 640 x 360 (Default)
	Third Stream (Closed by Default)	720 x 576, 704 x 288, 640 x 360, 352 x 288
Frame Rate	30 fps at 2880 x 1620, 30 fps at 2560 x 1440, 30 fps at 2304 x 1296, 30 fps at 1920 x 1080 (60 / 50 Hz) * The frame rate and performance may vary depending on the number of connections and data bitrates (different scenes).	
Video Analytics	Motion Detection, Tampering Alarm, Audio Detection *Tampering alarm and audio detection are only accessible through the camera's Web interface, which can be used to trigger alerts such as e-mail and FTP	
Image Setting	Brightness, Saturation, Contrast, Sharpness, Image Orientation (Flip, Mirror, 0°, 180°)	

Audio		
Audio Compression		G.711
Audio Support		Two-way Audio
Deep Learning Function		
AI Analytics		Cross Line, Intrusion, Enter Area, Leave Area, Face Detection, People Flow Counting, Crowd Density Monitoring
Network		
Interface		10/100 Ethernet
Protocol		802.1x, ARP, DHCP, DDNS, DNS, DynDNS, FTP, HTTP, HTTPS, ICMP, IGMP, IPv4, NTP, PPPoE, QoS, RTCP, RTP, RTSP, SMTP, SNMP, TCP, UDP, UPnP, ONVIF (Profile G, S, T)
Mechanical		
Connectors	Power	DC 12V, PoE+ (IEEE 802.3at)
	Ethernet	10/100 Base-TX, RJ-45 connector
	Audio	Two-way Audio (Built-in microphone and speaker)
	Local Storage	Micro SD card slot (SD / SDHC / SDXC / UHS-I, Class 10) *UHS-II card types are not supported.
	Digital I/O	I/O wires
	RS-485	RS-485 wires
Operation		
Pan Travel		350°
Tilt Travel		0° ~ 90°
Manual Speed	Pan	0.1° ~ 60°/s
	Tilt	0.1° ~ 50°/s
Preset Speed	Pan	60°/s
	Tilt	50°/s
Presets	Max. Number	255
Patrol	Max. Number	16
	Max. Actions Allowed	32
OSD		8
Privacy Mask		24
Proportional Pan & Tilt		Manual (Pan and tilt speed proportional to zoom ratio)
Automatic Function		Preset, Patrol
Mechanical Flip		Yes
Digital Slow Shutter		On / Off
Motion Detection		On / Off
Wide Dynamic Range		On / Off
Day/Night: Mechanical IR Cut Filter		On / Off
Image Rotation		Normal, Flip Vertical, Flip Horizontal, 180°
3D Noise Reduction		0 ~ 255
Alarm	Digital I/O	1 Input, dry contact, NO / NC 1 Relay Output (AC 125V 0.5A / DC 30V 1A)
	Reaction	Alarm Output, PTZ to Preset, Trigger Storage
General		
Operating Temperature		-10°C ~ 50°C (14°F ~ 122°F)
Humidity		95% (non-condensing)
Dimensions		Ø129 x 143.6 mm (Ø5.1" x 5.7")
Weight		0.75 kg (1.65 lb)
Power Source		DC 12V, PoE+ (IEEE 802.3at)
Power Consumption		15W
Regulatory		CE, FCC, RoHS compliant
Web Interface		
Installation Management		Web-based configuration
Maintenance		Firmware upgrade through Web Browser or Utility
Access from Web Browser		Live View, Video Recording, Change Video Quality, Bandwidth Control, Image Snapshot, Text Overlay, Image Masking

Language	Czech, English, French, German, Hungarian, Italian, Japanese, Polish, Portuguese, Russian, Spanish, Traditional Chinese
Software Applications	
Software Supported	GV-DVR / NVR (V8.9.1), GV-VMS (V17.4.3 / V18.2.1), GV-Control Center (V3.8.0 / V4.0.1), GV-Edge Recording Manager Windows Version (V2.0.0), GV-Recording Server / Video Gateway (V2.0.1), GV-Redundant / Failover Server (V1.2.0), GV-Mobile Server (V1.5.1), GV-AI Guard (V1.0.0)
Smart Device Access	GV-Eye for iOS and Android
Live Viewing	Browser (IE, Edge, Chrome, Firefox, Safari), Mobile App





Note:



- It is required to apply patch files to some of the supported software.
- Do not use clothes or any ordinary material to clean the camera cover since they may result in scratches.
- Mind the following when using an inserted memory card for recording:
 - Recorded data on the memory card can be damaged or lost if the data are accessed while the camera is under physical shock, power interruption, memory card detachment or when the memory card reaches the end of its lifespan. No guarantee is provided for such causes.
 - The stored data can be lost if the memory card is not accessed for a long period of time. Back up your data periodically if you seldom access the memory card.
 - Memory cards are expendable and their durability varies according to the conditions of the installed site and how they are used. Back up your data regularly and replace the memory card annually.
 - To avoid power outage, it is highly recommended to apply a battery backup (UPS).
 - For better performance, it is highly recommended that you use a micro SD card of SDHC/SDXC, Class 10.
 - Replace the memory card when its read/write speed is lower than 6 MB/s or when the memory card is frequently undetected by the camera.
- Specifications are subject to change without notice.

Packing List

- GV-PTZ5810-IR Mini PTZ
- Screw Kit
- Drill Template Paster
- Download Guide

Accessories

Model No.	Name		Details
GV-Mount107	Pendant Bracket		Dimensions: Ø120 x 334 mm (Ø4.72" x 13.15") Weight: 0.74 kg (1.63 lb) *must be used with GV-Mount212P
GV-Mount211P	Wall Mount and Junction Box		Dimensions: Ø233 x 125 x 125 mm (Ø9.2" x 4.9" x 4.9") Weight: 1 kg (2.2 lb)
GV-Mount212P	Wall Box Mount		Dimensions: Ø126 x 36 mm (Ø5.0" x 1.4") Weight: 0.22 kg (0.48 lb)
GV-Mount300-2	Convex Corner Mount		Dimensions: 137 x 233 x 160 mm (5.4" x 9.17" x 6.3") Weight: 1.65 kg (3.64 lb)
GV-Mount310-2	Concave Corner Mount		Dimensions: 111.2 x 369.9 x 210 mm (2.6" x 11.4" x 6.6") Weight: 1.65 kg (3.64 lb)

GV-Mount420	Pole Mount Bracket		Dimensions: $\varnothing 120 \times 120 \times 53.4$ mm ($\varnothing 4.7'' \times 4.7'' \times 2.1''$) Weight: 0.45 kg (0.99 lb) Steel Strap Diameter: $\varnothing 67 \sim 127$ mm ($\varnothing 2.6'' \sim 5''$) *must be used with GV-Mount211P
GV-Mount704	Extension Tube		Dimensions: $\varnothing 3.5 \times 10$ or 20 or 30 or 50 cm ($\varnothing 1.38'' \times 3.9''$ or 7.9" or 11.8" or x 19.7") Weight: 225 g or 360 g or 500 g or 780 g (0.5 lb or 0.79 lb or 1.1 lb or 1.72 lb) *must be used with GV-Mount107
GV-POE Switch	GV-POE Switch is designed to provide power along with network connection for IP devices. The GV-POE Switch is available in various models with different numbers and types of ports.		
Power Adapter	Contact our sales representatives for the countries and areas supported.		