

GV-GBLP8900 Cloud AI 8MP Dual-Lens Panoramic H.265 Super Low Lux WDR Full Color Warm LED IR Bullet IP Camera



- Direct-to-Cloud
- AI deep learning: AI Perimeter Protection & Classification (Human, Vehicle)
- 180° panoramic splicing view
- 1/2.7" progressive scan CMOS sensor
- Triple streams from H.265, H.264 or MJPEG
- Min. illumination at 0.0032 lux
- Up to 30 fps at 4640 x 1760
- Smart Warm LED distance up to 20 m (65 ft)
- Intelligent IR
- IR distance up to 30 m (100 ft)
- Day and Night function (with removable IR-cut filter)
- Ingress protection (IP67)
- DC 12V / PoE (IEEE 802.3af)
- Built-in microSD card slot (SD / SDHC / SDXC) for local storage
- Built in microphone and speaker
- Two-way audio capable
- Defog
- 3D noise reduction
- GV-Center V2 connection
- AI analytics (Line Crossing, Region Entrance, Region Exiting, Region Intrusion, Target Counting, Heat Map, Loitering Detection, Illegal Parking Detection, Face Detection, Video Metadata)
- Active Deterrence: Alarm sound and LED lights triggered upon AI events
- Smart lighting switch between IR LED (for motion detection) and Warm LED (for people, vehicle and motorcycle detection)
- Motion detection
- Text overlay
- Privacy mask
- 20 languages supported
- ONVIF (Profile G, S, T, M) conformant

Introduction

GV-GBLP8900 is a 180° dual-lens splicing bullet IP camera, equipped with smart warm LEDs for full color surveillance during nighttime. The camera supports H.265 video codec to achieve a better compression ratio while maintaining high-quality pictures at reduced network bandwidths. GV-GBLP8900 adheres to the IP67 standard and can be powered through PoE.

Empowered by deep learning algorithms, its AI technology distinguishes humans and vehicles from other moving objects. When integrated with GeoVision Video Management Software (VMS), it supports AI perimeter protection, real-time alert, event playback, and more. By connecting the camera to the cloud-based data center and video surveillance solution, GV-Cloud VMS, thousands of on-site videos, alarm devices, and AI events can be monitored and managed from a single platform.

180 Degree Panoramic Splicing View



Deep Learning Function

Face Detection

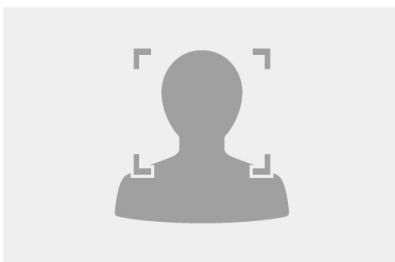

AI Perimeter Protection

(Region Intrusion, Line Crossing, Region Entrance, Region Exiting)

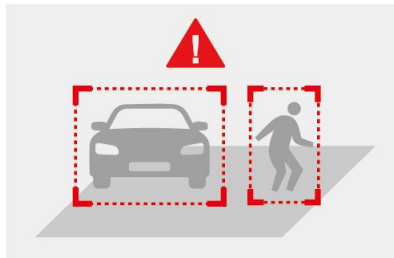

People Counting

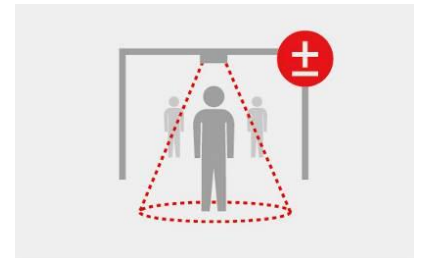

Specifications

Camera		
Image Sensor		1/2.7" progressive scan CMOS x 2
Picture Elements		4640 (H) x 1760 (V)
Minimum Illumination	Color	0.0032 Lux (F1.6, AGC ON)
	IR On	0 Lux
Shutter Speed		Automatic, Manual (1/3 ~ 1/100000 sec)
White Balance		Automatic, Manual
Gain Control		Automatic, Manual
S/N Ratio		50 dB
WDR		Yes
Dynamic Range		90 dB
Lens		
Megapixel		8 MP
Day/Night		Yes (with removable IR-cut filter)
Focal Length		2.8 mm
Lens Type		Fixed
Maximum Aperture		F/1.6
Mount		M12

FOV	Horizontal	180°			
	Vertical	66°			
	Diagonal	180°			
Operation	Focus	Fixed			
	Zoom	Fixed			
	Iris	Fixed			
Active Deterrence LED		1 red and blue LED			
IR LED	Quantity	2 IR LEDs			
	Max. IR Distance	30 m (100 ft)			
Smart Illumination	Quantity	2 Warm LEDs			
	Max. Warm LED Light Distance	20 m (65 ft)			
DORI		Detect	Observe	Recognize	Identify
Lens	2.8 mm	60 m (196 ft)	24 m (79 ft)	12 m (39 ft)	6 m (20 ft)
Operation					
Video Compression		H.265, H.265+, H.264, H.264+, MJPEG			
Video Streaming		Triple streams			
Video Resolution	Main Stream	4640 x 1760 (Default), 3632 x 1632, 3200 x 1200, 2304 x 864			
	Sub Stream	2048 x 768 (Default), 1600 x 608, 1200 x 448			
	Third Stream	1200 x 448 (Default), 960 x 368, 640 x 240			
Frame Rate		30 fps at 4640 x 1760 / 3632 x 1632 / 3200 x 1200 / 2304 x 864 / 2048 x 768 / 1600 x 608 / 1200 x 448 / 960 x 368 / 640 x 240 (60 Hz) 25 fps at 4640 x 1760 / 3632 x 1632 / 3200 x 1200 / 2304 x 864 / 2048 x 768 / 1600 x 608 / 1200 x 448 / 960 x 368 / 640 x 240 (50 Hz) *The frame rate and performance may vary depending on the number of connections and data bitrates (different scenes).			
Maximum Throughput		100 Mbps			
Maximum Streams *When the total bitrate is within the maximum throughput		10 *By default, 2 connections are occupied whether connected to GV-Cloud VMS or not.			
Video Analytics		Motion Detection, Video Exception (Scene Change, Video Blur, Abnormal Color), Object Abandoned/Missing Detection			
Smart Alarm		Motion Detection, SD Card Error, SD Card Full, IP Address Conflict, Cable Disconnection, Video Exception (Scene Change, Video Blur, Abnormal Color), Audio Exception			
Image Setting		Brightness, Contrast, Hue, Saturation, Sharpness, 3D Noise Reduction, BLC, Antiflicker, White Balance, Shutter, Gain			
Dual Redundant Images		Yes (for failsafe firmware upgrade)			
Audio Compression		G.711			
Audio Support		Two-way audio			
Digital I/O	Input	1 Input, dry contact, NO / NC			
	Output	1 Relay Output (1A 30V DC / 0.3A 125V AC)			
Deep Learning Function					
AI Analytics		Face Event: Face Detection Smart Event: - Line Crossing, Region Entrance, Region Exiting, Region Intrusion, Target Counting, Heat Map, Video Metadata: Human & Vehicle classification - Loitering Detection, Illegal Parking Detection *Face events and smart events cannot be enabled at the same time. *A maximum of 2 smart detection functions are suggested at a time to ensure comprehensive detection results and the optimized performance by the camera. *Once connected to GV-Cloud VMS / GV-Center V2, up to 2 smart detection functions are supported.			
Video Metadata	People	Gender, Age, Top / Bottom (Type, Color), Accessories (Hat, Bag, Face Mask, Glasses)			
	Vehicle	Type, Color, Brand, Model			
	Non-Motor Vehicle	Type			

Network			
Interface	10/100 Ethernet		
Protocol	802.1X authentication (EAP-TLS, EAP-MD5), DDNS, DHCP, FTP, HTTP POST, HTTP, HTTPS, IPv4, IPv6, NTP, ONVIF (Profile G, S, T, M), PPPoE, QoS, RTCP, RTMP, RTP, RTSP, SMTP, SNMP, UDP, UPnP		
Mechanical			
Camera Angle Adjustment	Pan	0 ~ 360°	
	Tilt	0 ~ 90°	
	Rotate	0 ~ 360°	
Connectors	Power	DC jack	
	Ethernet	RJ-45 connector	
Connectors	Audio	Built-in microphone	Yes
		External microphone required	Yes (audio jack, 3.5 mm or 0.14 in)
		Built-in speaker	Yes
		External speaker required	Yes (audio jack, 3.5 mm or 0.14 in)
		* Choose either the built-in or external option for devices with a microphone or speaker. * The Audio In port only supports microphones with a power supply.	
Connectors	Digital I/O	4-pin terminal block pitch 3.5 mm (0.14")	
Connectors	Local Storage	microSD card slot (SD / SDHC / SDXC), up to 256 GB	
General			
Operating Temperature	-30 ~ 60°C (-22 ~ 140°F)		
Humidity	0 ~ 95% (no condensation)		
Power Source	DC 12 V, 1.25 A / PoE (IEEE 802.3af)		
Max. Power Consumption	DC 12 V: Max. 9 W PoE: Max. 10.2 W		
Dimensions	225.9 x 102.3 x 85.8 mm (8.9 x 4.0 x 3.4 in)		
Weight	0.906 kg (2.0 lb)		
Ingress Protection	IP67		
Certification	CE, FCC, RoHS compliant		
Web Interface			
Installation Management	Web-based configuration		
Maintenance	Firmware upgrade through Web Browser or Utility		
Access from Web Browser	Live View, Playback, Video Recording, Image Quality, Bandwidth Control, Image Snapshot, Digital Zoom, Text Overlay, Image Masking, Intelligent Mark		
Language	Chinese Traditional, Czech, Dutch, English, French, German, Greek, Hungarian, Italian, Japanese, Korean, Norwegian, Polish, Portuguese, Romanian, Russian, Spanish, Spanish (Latin America), Turkish, Ukrainian		
Software Applications			
Software Supported	GV-VMS (V17.4.8 / V18.3.5 / V20.0.2 or later, patch files required), GV-Edge Recording Manager (V2.3.1 or later), GV-Control Center (V4.3.0 or later), GV-Recording Server (V2.1.1 or later), GV-Center V2 (V20.1 or later), GV-Cloud VMS (V1.5.0 or later), GV-IP Device Utility (V9.0.5 or later)		
Smart Device Access	GV-Eye for iOS and Android (V3.5.1 or later)		
Live Viewing	Web Browser (Edge, Chrome, Firefox, Safari), Mobile App		





Note:

- To use GV-Cloud VMS, avoid connecting to other GV-Software at the same time.
- To use GV-Cloud VMS, a microSD card must be installed. Industrial-grade microSD cards are recommended to avoid event recordings writing failure.
- Upon the initial connection of GV-Cloud IP Cameras to GV-Cloud VMS, the Standard Plan will be provided for free for 180 days.
- GV-Center V2 Standard / Pro can only receive motion events from GV-Cloud IP Cameras. To receive AI and PVD events, GV-Center V2 AI is required.
- All specifications are subject to change without notice.

Packing List

- | | |
|------------------------------|--------------------------|
| 1. GV-GBLP8900 Bullet Camera | 4. Drill Template Paster |
| 2. Waterproof Rubber Set | 5. Download Guide |
| 3. Screw Kit | |

Accessories

Model No.	Name		Details
GV-Mount314 (must be used with GV-Mount506-1)	Corner Mount Bracket		Dimensions: 215 x 121.4 x 215 mm (8.46 x 4.78 x 8.46 in) Weight: 2.05 kg (4.52 lb)
GV-Mount470 (must be used with GV-Mount506-1)	Pole Mount Bracket		Dimensions: 163.3 x 54.5 x 215 mm (6.43 x 2.15 x 8.46 in) Weight: 1.10 kg (2.43 lb)
GV-Mount506-1	Junction Box		Dimensions: 117.9 x 143.3 x 47 mm (4.64 x 5.64 x 1.85 in) Weight: 0.38 kg (0.84 lb)
GV-PA191	PoE Adapter		GV-PA191 is a Power over Ethernet (PoE) adapter designed to provide power to the IP device through a single Ethernet cable.
GV-PA301	Gigabit PoE Adapter		GV-PA301 is a Gigabit Power over Ethernet (PoE) adapter.
GV-POE Switch	GV-POE Switch is designed to provide power along with network connection for IP devices. The GV-POE Switch is available in various models with different numbers and types of ports.		
Power Adapter	Contact our sales representatives for the countries and areas supported.		

Dimensions

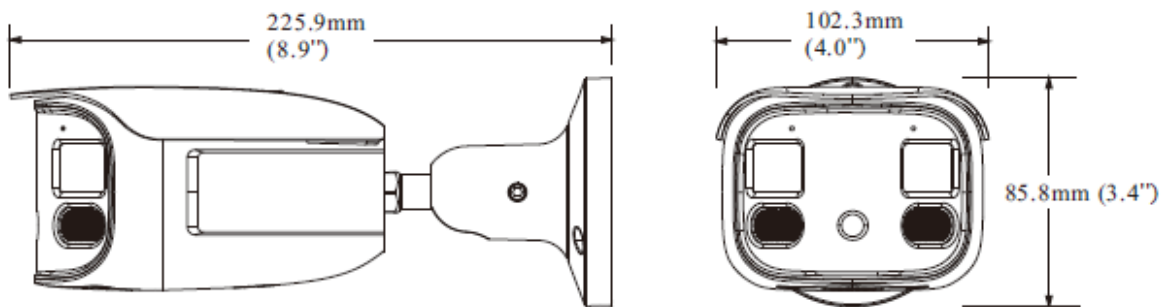

Mounting Type

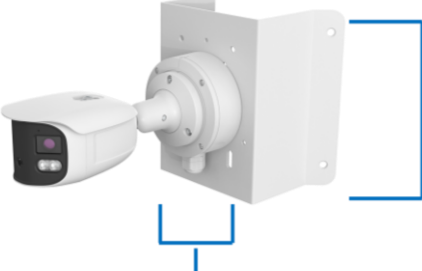
Junction Box Mount	Junction Box Mount	Corner Bracket Mount
GV-Mount506-1	GV-Mount506-1	GV-Mount314
 <p data-bbox="303 604 478 627">GV-Mount506-1</p>	 <p data-bbox="877 604 1037 627">GV-Mount506-1</p> <p data-bbox="1197 425 1340 448">GV-Mount314</p>	

Junction Box Mount	Pole Bracket Mount
GV-Mount506-1	GV-Mount470
 <p data-bbox="622 1097 782 1120">GV-Mount506-1</p> <p data-bbox="941 896 1085 918">GV-Mount470</p>	