

# 5MP HDCVI Security System

Four (4) 5MP HDCVI Eyeball Cameras with One (1) Four-channel Analytics+ 4K HDCVI DVR



## Wiz Sense

WizSense Series devices combine Dahua's powerful Analytics+ with an intuitive and easy to use interface. WizSense devices offer Smart Motion Detection and Perimeter Protection functions that focus on human and vehicular images and ignore irrelevant images to capture important video while reducing false alarms. WizSense Series devices provide powerful general surveillance for small to medium size businesses at a sensible price.

### System Overview

The Dahua HDCVI Security System provides the components to quickly install a video surveillance solution. The HDCVI cameras offer the clarity of 5 MP video with a 16:9 aspect ratio, and the HDCVI DVR offers built-in motion detection algorithms, alarm triggers, and customized recording modes. The cameras and the HDCVI DVR supports multiple video outputs making the kit compatible with many existing systems. The kit features Dahua's HDCVI technology that leverages an existing coaxial infrastructure, saving time and costs from running networking and power cables.

### Functions

#### Perimeter Protection

Dahua Analytics+ includes Tripwire and Intrusion functions that offer custom tripwires based on object type for automation in limited access areas. Perimeter Protection requires less pixels to detect an object to deliver improved accuracy and decreased false alarms due to lights, weather, trees, or animals.

#### Smart Motion Detection

The Smart Motion Detection, a component of Dahua's Analytics+ technology, improves alarm accuracy and decreases the number of false alarms. The advanced SMD algorithm analyzes a scene for human or vehicle motion, while filtering out other motion due to trees, leaves, animals, weather, and triggers an alarm when detected.

#### AI Coding

The AI Coding function puts recording emphasis on human or vehicular objects in the video scene. This technology, based on constant bit rate (CBR), dynamically allocates increased bit rate to the target object while reducing the bit rate allocated to background objects. AI Coding reduces bit rate and storage requirements by up to 50% when compared to the H.265 video compression standard.

### HDCVI Cameras

- 1/2.7-in. 5 MP Progressive-scan CMOS Sensor
- 5 MP at 25 fps Maximum Resolution, 2.8 mm Fixed Lens
- 16:9 Aspect Ratio for no Image Stretching
- Maximum IR Length 30 m (98.43 ft), Smart IR
- IP67 Ingress Protection

### HDCVI DVR

- 2 TB Pre-installed Hard Disk Drive
- Four-channel Penta-brid Recorder, Dual-streaming
- Smart H.265+ and Smart H.264+ Dual Codec
- 5 MP at 12 fps or 4K at 7 fps Recording Resolution on All HDCVI Channels
- AI Coding Technology for High-quality Human/Vehicle Video
- Perimeter Protection and Smart Motion Detection (SMD)

### Flexible Recording

The HDCVI DVR offers a variety of configurable recording options and schedules that saves HDD space and active monitoring time. The HDCVI DVR monitors incoming video and can be programmed to record if motion is detected or if an alarm is triggered. The HDCVI DVR can also be programmed to record on a schedule or at different intervals. The recording options and schedules can be set for each individual camera or copied to all cameras.

### Long Distance Transmission

HDCVI technology guarantees real-time transmission over long distances without loss of video quality. HDCVI devices provide the same resolution as most IP network camera systems using existing RG-59, RG-6, or CAT 6 UTP cabling.

### Multi-format Support

The camera and HDCVI DVR supports multiple video formats including, HDCVI, CVBS, AHD, and TVI. The camera can switch between these four formats via the OSD menu or the switch located on the video output cable making the camera compatible with not only HDCVI DVRs but also most existing HD/SD DVRs. The HDCVI DVR automatically recognizes the incoming signals of each attached camera without any setup, making installation easy and operation convenient.

### Environmental

With a temperature range of  $-40^{\circ}\text{C}$  to  $+60^{\circ}\text{C}$  ( $-40^{\circ}\text{F}$  to  $+140^{\circ}\text{F}$ ), the cameras are designed for extreme temperature environments. The cameras, subjected to rigorous dust and water immersion tests, are certified to the IP67 rating making them suitable for demanding outdoor applications.

The HDCVI DVR features an operating temperature of  $-10^{\circ}\text{C}$  to  $+55^{\circ}\text{C}$  ( $+14^{\circ}\text{F}$  to  $+131^{\circ}\text{F}$ ).

## Technical Specification

### A51BJ02 5MP HDCVI Eyeball Camera

#### Camera

Image Sensor	1/2.7-in. CMOS Sensor
Effective Pixels	2880 (H) x 1620 (V), 5 MP
Aspect Ratio <sup>1</sup>	16:9
Scanning System	Progressive
Electronic Shutter Speed	1/30 s to 1/100,000 s
Minimum Illumination	Color: 0.01 lux at F1.6, 30 IRE 0 lux with IR on
S/N Ratio	More than 65 dB
IR Distance	Up to 30.0 m (98.43 ft)
IR On/Off Control	Auto, Manual
IR LEDs	One (1)

#### Lens

Lens Type	Fixed-focal
Mount Type	M12
Focal Length	2.8 mm
Maximum Aperture	F1.6
Angle of View	Horizontal: 111° Vertical: 58° Diagonal: 132°
Close Focus Distance	900.0 mm (35.43 in.)

#### Installation Angle

Range	Pan: 0° to 360° Tilt: 0° to 78° Rotation: 0° to 360°
-------	--

#### DORI Distances<sup>2</sup>

Detect (8 ppf)	Observe (19 ppf)	Recognize (38 ppf)	Identify (76 ppf)
63.60 m (208.70 ft)	25.40 m (83.30 ft)	12.701 m (41.70 ft)	6.40 m (21.0 ft)

#### Video

Resolution	5 MP (2880 x 1620), 4 MP (2560 x 1440), 1080p (1920 x 1080), 960H (960 x 480)	
Maximum Frame Rate	HDCVI	5 MP at 25 fps, 4 MP at 30 fps, 1080p at 30 fps
	AHD	4 MP at 30 fps
	TVI	4 MP at 30 fps
	CVBS	960H
Video Output	One (1) BNC Output, HDCVI, AHD, TVI, CVBS switchable	
Video Transmission <sup>3</sup>	RG-59/U Coax	720p: 800 m (2624.67 ft) 1080p: 500 m (1640.42 ft) 5 MP: 500 m (1640.42 ft)
	RG-6/U Coax	720p: 1200 m (3937.01 ft) 1080p: 800 m (2624.67 ft) 5 MP: 700 m (2296.59 ft)
	CAT 6 UTP (balun required)	720p: 450 m (1476.38 ft) 1080p: 300 m (984.25 ft) 5 MP: 300 m (984.25 ft)
Day/Night	Auto (ICR)	
OSD Menu	Multi-language	
BLC Mode	BLC, HLC, DWDR	
WDR	Digital WDR	
Gain Control	Auto, Manual	
Noise Reduction	2D NR	
White Balance	Auto, Manual	
Smart IR	Auto, Manual	

#### Certifications

Safety	UL60950-1 CAN/CSA C22.2 No.60950-1
Electromagnetic Compatibility (EMC)	FCC CFR 47 Part 15 subpart B, ANSI C63.4-2014, EN55032:2015, EN 61000-3-2:2014, EN 61000-3-3:2013, EN55024:2010+A1:2015, EN 55035:2017, EN50130-4:2011+A1:2014, EN 62368-1:2014+A11:2017

#### Electrical

Power Supply	12 VDC ± 30%
Power Consumption	Maximum 3.2 W (12 VDC, IR on)

#### Environmental

Operating Conditions	-40° C to +60° C (-40° F to +140° F) Less than 95% RH
Storage Conditions	-40° C to +60° C (-40° F to +140° F) Less than 95% RH
Ingress Protection	IP67

#### Construction

Casing	Metal
Dimensions	ø94.0 mm x 85.60 mm (ø3.70 in. x 3.37 in.)
Net Weight	0.31 kg (0.68 lb)
Gross Weight	0.44 kg (0.97 lb)

- To view the 16:9 video output on a Dahua HDCVI DVR you must update the DVR to the latest firmware. Obtain the latest firmware on the Dahua Wiki at <https://dahuawiki.com/Recorders>.
- The DORI distance is a measure of the general proximity for a specific classification to help pinpoint the right camera for your needs. The DORI distance is calculated based on sensor specifications and lab test results according to EN 62676-4, the standard that defines the criteria for the Detect, Observe, Recognize and Identify classifications.
- Transmission distance results verified by real-scene testing in Dahua's test laboratory. Actual transmission distances may vary due to external influences, cable quality, and wiring structures.

## Technical Specification

### X81B1E2 4-channel HDCVI DVR with Analytics+

#### System

Main Processor	Embedded Processor
Operating System	Embedded LINUX

#### Analytics+ Perimeter Protection<sup>1,2</sup>

Performance	<ul style="list-style-type: none"> <li>Human and Vehicle object classification</li> <li>Decreased false alarms from leaves, lights, animals</li> <li>Configure function on a single channel</li> <li>10 Tripwire/Intrusion rules</li> </ul>
Live View	<ul style="list-style-type: none"> <li>Configure Rule and Object Inspection area</li> <li>Display object classification, event types, trigger time, image snapshot, and object types</li> <li>Export event playback 10 seconds prior to or after event</li> </ul>
Playback	<ul style="list-style-type: none"> <li>Search by channel, time, event type, and target type</li> <li>Search event playback 10 seconds prior to or after event</li> <li>Snapshot capacity: 500,000</li> </ul>

#### Analytics+ Smart Motion Detection<sup>1,2</sup>

Performance	<ul style="list-style-type: none"> <li>Detect motion based on object classification (human or vehicle)</li> <li>Decreased false alarms from leaves, lights, animals</li> <li>Configure functions on four(4) channels</li> </ul>
Preview	<ul style="list-style-type: none"> <li>Configure and inspect detection area</li> </ul>
Playback	<ul style="list-style-type: none"> <li>Search by channel, time, event type, and target type</li> <li>Search event playback 10 seconds prior to or after event</li> </ul>

#### Interface

Analog Camera Input	Four (4) Channels, BNC
HDCVI	8 MP, 6 MP, 5 MP, 4 MP, 1080p at 30 fps, 720p at 60 fps, 720p at 30 fps
AHD	4K, 5 MP, 4 MP, 3 MP, 1080p at 30 fps, 720p at 30 fps
TVI	4K, 5 MP, 4 MP, 3 MP, 1080p at 30 fps, 720p at 30 fps
CVBS	NTSC
IP Camera Input	4+4 Channels, each channel up to 8 MP
Audio	Input: Four (4) Channels, RCA Output: One (1) Channel, RCA
Two-way Talk	Audio Input Channel 1 In/ Audio Output, RCA

#### Recording

Compression	AI Coding, Smart H.265+, H.265, Smart H.264+, H.264	
Recording Resolution	8 MP, 6 MP, 5 MP, 4 K-N, 4 MP, 3 MP, 4 M-N, 1080p, 720p, 960H, D1, CIF	
Record Rate	<b>Main Stream</b>	8 MP at 7 fps; 6 MP at 10 fps, 5 MP at 12 fps, 4 K-N, 4 MP or 3 MP at 15 fps, 4 M-N, 1080p, 720p, 960H, D1, or CIF at 30 fps
	<b>Sub Stream</b>	960H, D1, or CIF at 12 fps
Max. Incoming Bandwidth	64 Mbps	
Bit Rate	32 Kbps to 6144 Kbps per Channel	
Record Mode	Manual, Schedule (Regular, Continuous), MD (Video Detection: Motion Detection, Video Loss, Tampering), Alarm, Stop	
Record Interval	1 to 60 minutes (default: 60 minutes), Pre-record: 1 to 30 s, Post-record: 10 to 300 s	
Audio Compression	G.711a, G.711Mu, PCM	
Audio Sample Rate	8 KHz, 16 bits per Channel	
Audio Bit Rate	64 Kbps per Channel	

#### Display

Interface	One (1) HDMI (3840 x 2160) One (1) VGA (1920 x 1080)	
Spot Output	HDMI or VGA, configurable, 1920 x 1080 max resolution	
Native Output Resolution	HDMI	3840 x 2160, 2560 x 1440, 1920 x 1080, 1280 x 1024, 1280 x 720
	VGA	1920 x 1080, 1280 x 1024, 1280 x 720
Maximum Playback Decoding		
Multi-screen Display	IP extension mode disabled: 1/4 IP extension mode enabled: 1/4/8/9	
Fisheye Dewarp	Supported via Web Interface	
On-screen Display	Camera Title, Time, Video Loss, Camera Lock, Motion Detection, Recording	

#### Network

Interface	One (1) RJ45 (100 Mbps) Port
Network Function	HTTP, TCP/IP, IPv4/IPv6, UPnP, RTSP, UDP, SMTP, NTP, DHCP, DNS, IP Filter, PPPoE, DDNS, FTP, Alarm Server, P2P, IP Search (Supports Dahua IP cameras, DVRs, NVS)
Max. User Access	128 Users
Mobile Operating System	IOS, Android
Interoperability	ONVIF 16.12, CGI Conformant

#### Video Detection and Alarm

Trigger Events	Recording, PTZ, Tour, Video Push, Email, FTP, Snapshot, Buzzer and Screen Tips
Video Detection	Motion Detection, MD Zones: 396 (22 x 18), Video Loss, Tampering, and Diagnosis
Alarm Input	Eight (8) Channels
Relay Output	Three (3) Channels

#### Playback and Backup

Playback	1/4
Search Mode	Time/Date, Alarm, MD and Exact Search (accurate to 1 second)
Playback Function	Play, Pause, Stop, Rewind, Fast Play, Slow Play, Next File, Previous File, Next Camera, Previous Camera, Full Screen, Repeat, Shuffle, Backup Selection, and Digital Zoom
Backup Mode	USB Device/Network

#### Storage

Internal HDD	One (1) SATA Ports, up to 10 TB capacity Kit ships with a 2 TB Hard Disk Drive
--------------	---

#### Auxiliary Interface

USB	Two (2) USB 2.0 Ports
RS485	One (1) Port for PTZ Control

1. The Analytics+ functions are disabled when the additional IP channels are active.  
2. The DVR is capable of processing two (2) channels of Perimeter Protection or four (4) channels of SMD at one time.

**X81B1E2 Technical Specification, continued**

Electrical

Power Supply	12 VDC, 2 A
Power Consumption	< 7 W, without HDD

Construction

Dimensions	
HDCVI DVR	Mini 1U, 325.0 mm x 257.0 mm x 55.0 mm (12.80 in. x 10.11 in. x 2.17 in.)
Net Weight	1.20 kg (2.70 lb)
Gross Weight	1.90 kg (4.20 lb)
Installation	Desktop

Video Transmission Distance

RG-59/U Coax	720p:	800 m (2624.67 ft)
	1080p:	500 m (1640.42 ft)
	4K/4MP:	500 m (1640.42 ft)
RG-6/U Coax	720p:	1200 m (3937.01 ft)
	1080p:	800 m (2624.67 ft)
	4K/4MP:	700 m (2296.59 ft)
CAT 6 UTP (balun required)	720p:	450 m (1476.38 ft)
	1080p:	300 m (984.25 ft)
	4K/4MP:	300 m (984.25 ft)

Environmental

Operating Conditions	-10° C to +55° C (+14° F to +131° F), 10% to 90% RH
Storage Conditions	-20° C to +70° C (-4° F to +158° F), 0% to 90% RH

Third-party Support

Third-party Support	Dahua, Arecont Vision, AXIS, Bosch, Brickcom, Canon, CP Plus, Dynacolor, Honeywell, Panasonic, Pelco, Samsung, Sanyo, Sony, Videotec, Vivotek, and others
---------------------	---

Certifications

Safety	EN 60950-1 IEC 60950-1
Electromagnetic Compatibility (EMC)	FCC CFR 47 Part 15 Subpart B EN 61000-3-2 EN 61000-3-3 EN 55032 EN 50130 EN 55024

**Ordering Information**

Type	Part Number	Description
1080p HDCVI Security System	C845E42A	
	• A51BJ02	5 MP HDCVI IR 2.8 mm Fixed Lens Eyeball Camera, 16:9 Aspect Ratio (x4)
	• X81B1E2	4-Channel Penta-brid 4K Mini 1U, 2 TB Digital Video Recorder (x1)
Camera Accessories, optional	PFA106	Mount Adapter (For use with PFB305W wall mount)
	PFA13A-E	Junction Box (For use alone or with PFA152-E pole mount)
	PFA150	Pole Mount (For use with PFA106 and PFB305W)
	PFA151	Corner Mount (For use with PFA106 and PFB305W)
	PFA152-E	Pole Mount (For use with PFB204W wall mount)
	PFA200G	Gang Box Adapter
	PFB204W	Wall Mount (For use alone or with PFA152-E pole mount)
	PFB220C	Ceiling Mont (For use with PFA106)
	PFB305W	Wall Mount (For use with PFA106)
	DH-PFM321D-US	12 VDC, 1 A Power Adapter
DH-PFM800-4K	4K Passive HDCVI Balun	

**Package Contents (individual devices ship with the following:)**

Product	Material
HDCVI Cameras	Printed Manual Printed Regulatory Guide Plastic Wall Anchors with Screws (x3) Mounting Template
Storage Device	Quick Network Guide Printed Manual Printed Regulatory Guide Mouse Adapter Power Adapter with Power Cord Ethernet Cable, RJ45 Alarm Cable Molex Units (x3) Screws (x4)

**Camera Accessories**

Optional:



PFA106  
Mount Adapter



DH-PFA13A-E  
Junction Box



PFA150  
Pole Mount

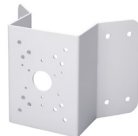

PFA151  
Corner Mount

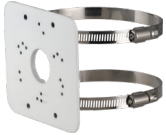

PFA152-E  
Pole Mount



DH-PFA200G  
Gang Box Adapter



PFB204W  
Wall Mount



PFB220C  
Ceiling Mount



PFB305W  
Wall Mount



DH-PFM321D-US  
12 VDC, 1 A Power  
Adapter



DH-PFM800-4K  
Passive HDCVI Balun

**A51BJ02 Mounting Diagram**

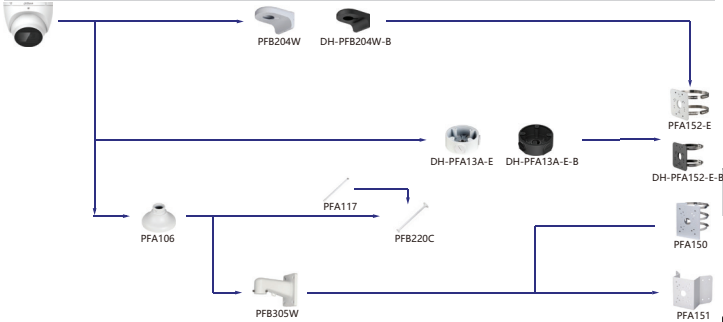

**A51BJ02 Dimensions (mm/in.)**

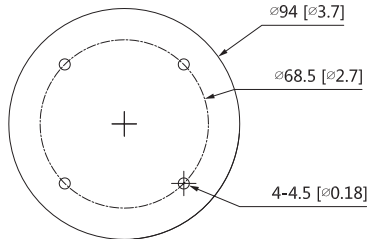
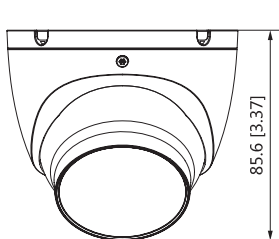

**X81B1E2 Dimensions (mm/in.)**

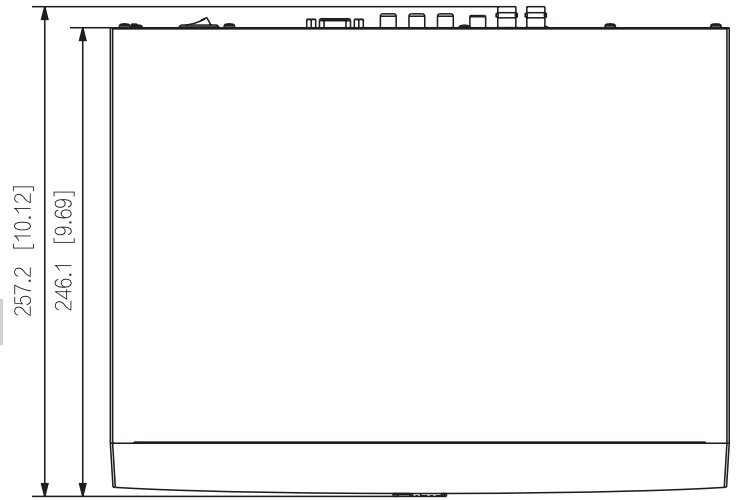
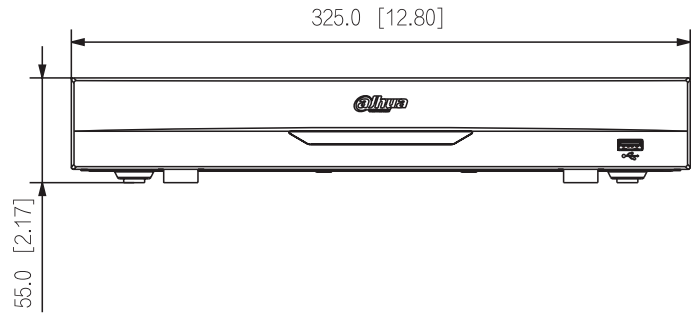

**Rear Panel**

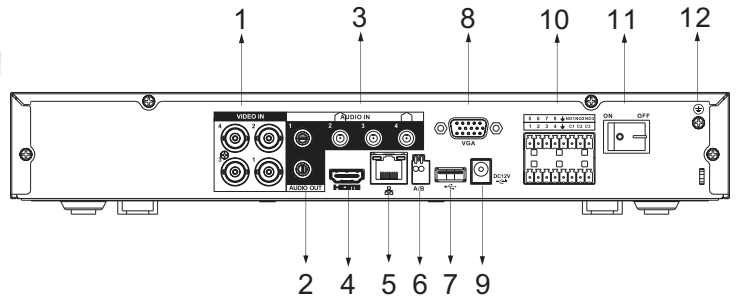

1	Video Input (x4 BNC)	7	USB Port
2	Audio Output (x1 RCA)	8	VGA Output
3	Audio Input (x4 RCA)	9	Power Input
4	HDMI Output	10	Alarm Input (x16) Alarm Output (x3)
5	RJ45 Ethernet Port (100 Mbps)	11	Power Switch
6	RS485 Port	12	Ground